

ACCESS SOLUTIONS



CONTENTS

Specifications

Introduction pg.3

Introduction pg.4

Information

Drawing & Design pg.5

The Lion Range

KAG Modular Configuration Type 1 pg.6

KAG Modular Configuration Type 1 - Side Mount pg.7

KAG Modular Configuration Type 2 pg.8

KAG Modular Configuration Type 2 - Side Mount pg.9

KAG Modular Configuration Type 3 pg.10

KAG Modular Configuration Type 3 - Side Mount pg.11

KAG Modular Configuration Type 4 pg.12

KAG Modular Configuration Type 4 - Side Mount pg.13

KAG Modular Configuration Type 5 pg.14

KAG Modular Configuration Type 5 - Side Mount pg.15

KAG Balustrading pg.16

Mount Systems

pg.17

Bollard Systems

KAG Bollards pg.18

Combinations

pg.19

pg.20

pg.21

Ordering

pg.20

Gripping Features

Maximise Grip & Safety pg.21

Quality Assured pg.22

Light Rail Feature pg.23



KAG
Safety Rail

KAG top rail:

Our KAG top rail is the most tested and certified handrail in the world. ALS Global mechanical tests resulted in the KAG tube outperforming standard tube by a minimum of 22% in load, crush and bend tests. QUT University “grip performance tests” certified at least 80% more grip in wet conditions, at least 160% more grip in dry conditions and at least 300% more grip in oily conditions.

KAG

Safety Rail



Minimum **80%** Extra Grip
Under Wet Conditions

Minimum **160%** Extra Grip
Under Dry Conditions

Minimum **300%** Extra Grip
Under Oily Conditions

Key Features:

- 🛡️ Cost effective
- 🛡️ Time efficient
- 🛡️ Modular flexibility
- 🛡️ No - weld assembly
- 🛡️ Flat pack delivery
- 🛡️ Reduced corrosion
- 🛡️ Colour options
- 🛡️ Heavy duty powder coat (90 to 120 microns)
- 🛡️ Chrome electro plated clamp system



Compliance:

- 🛡️ KAG handrails are designed and manufactured in accordance with BS EN ISO 14122-3
- 🛡️ KAG clamps are made with blackheart malleable iron and follow BS EN 1562 1997
- 🛡️ All galvanising is to ASTM A 123
- 🛡️ All steel pipe is in accordance with BS 1387 - 1985 (EN10255)

HIGH QUALITY CLAMPS

All KAG clamps are made by blackheart malleable iron and follows BS EN 1562 1997 with high quality finishes. All clamps have long life cycle usage and are designed and made for easy installation and maintenance.





SPECIAL SCREW DESIGN

KAG have a unique “set screw” design to give it the best possible attachment to the pipe. All screws are made from SUS 304 or high strength steel with dacromet 500 finish. This special screw design is one of the key factors in why KAG have the toughest modular system on the market to date.

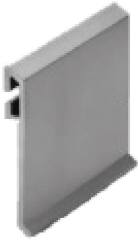



Toe Plate:

-  Aluminium / Steel
-  H = 100mm, 3.0mm thickness
-  Hot dip galvanised for steel or PE powder coat paint (optional)

*Aluminium toe plate for commercial use.



NEW - PANTHER Clamp

KAG's new PANTHER clamp range is aesthetically pleasing and a great alternative to the standard modular system.





Hot dip galvanising + Powder coating process



Hot dip galvanising + Powder coating process



Pipe Finishes:

-  - Hot dip galvanised
-  - Primed + polyester powder coat paint (90 to 120 microns)
-  - Hot dip galvanising + polyester powder coat paint







Clamp Finishes:

- Hot dip galvanised
- **PANTHER** - Hot dip galvanised + black polyester powder coat paint.



KAG:

Because we are Project driven - we can provide any of the following services to our valued clients:

-  CAD Design capabilities
-  Render Drawings
-  Fabrication Drawings
-  Site Audit on handrails in potential high-risk areas.
-  All our handrails & fittings are fabricated to Australian standards
-  We practice ISO quality control, with full traceability of work methods (including materials used) - right back to the mill.

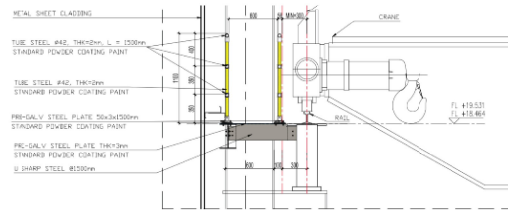
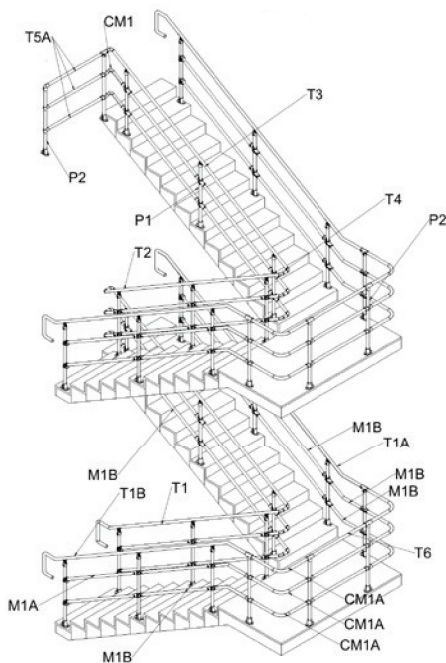

WALK WAY SECTION 1-1

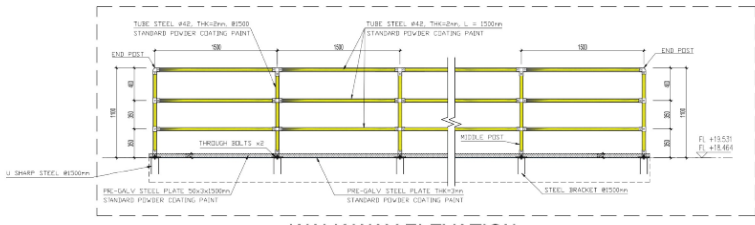

WALK WAY ELEVATION

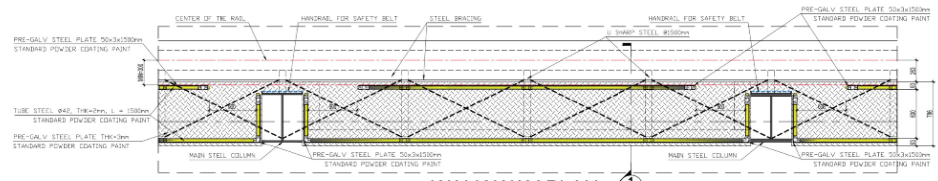

WALK WAY PLAN





Type 1:
Flat top mounted continuous

Material Combinations:

Tube / Clamp

- **GG** - Galvanised / Galvanised
- **GG** - Galvanised / PANTHER (Black)
- **PG** - Powdercoat / Galvanised
- **PP** - Powdercoat / PANTHER (Black)
- **GPG** - Galvanised Powdercoat / Galvanised
- **GPP** - Galvanised Powdercoat / PANTHER (Black)

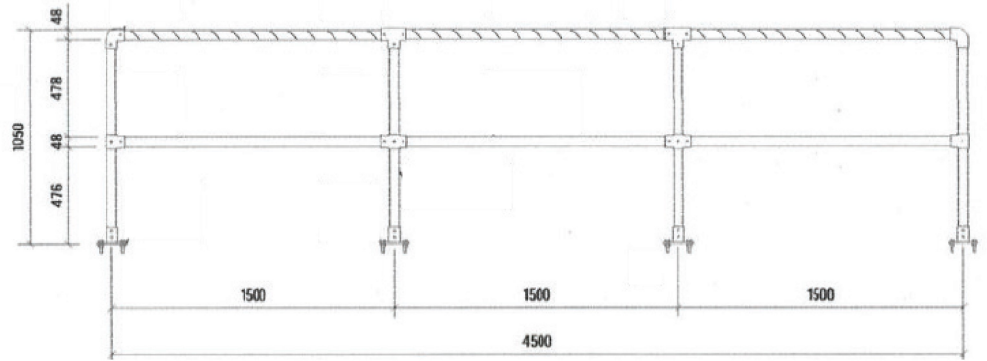

CODE	NB.	Wall	Material Combinations	Linear M	Toe-plate (T)
C140GG	40	3.2mm	GG	1.5m	
C140GGT	40	3.2mm	GG	1.5m	T
C140GP	40	3.2mm	GP	1.5m	
C140GPT	40	3.2mm	GP	1.5m	T
C140PG	40	3.2mm	PG	1.5m	
C140PGT	40	3.2mm	PG	1.5m	T
C140PP	40	3.2mm	PP	1.5m	
C140PPT	40	3.2mm	PP	1.5m	T
C140GPG	40	3.2mm	GPG	1.5m	
C140GPGT	40	3.2mm	GPG	1.5m	T
C140GPP	40	3.2mm	GPP	1.5m	
C140GPPT	40	3.2mm	GPP	1.5m	T
C132GG	32	3.2mm	GG	1.5m	
C132GGT	32	3.2mm	GG	1.5m	T
C132GP	32	3.2mm	GP	1.5m	
C132GPT	32	3.2mm	GP	1.5m	T
C132PG	32	3.2mm	PG	1.5m	
C132PGT	32	3.2mm	PG	1.5m	T
C132PP	32	3.2mm	PP	1.5m	
C132PPT	32	3.2mm	PP	1.5m	T
C132GPG	32	3.2mm	GPG	1.5m	
C132GPGT	32	3.2mm	GPG	1.5m	T
C132GPP	32	3.2mm	GPP	1.5m	
C132GPPT	32	3.2mm	GPP	1.5m	T

*Mid rail sizing can vary to suit individual order / project.



Type 1 - Side Mount:
Flat side mounted continuous

Material Combinations:

Tube / Clamp

- GG - Galvanised / Galvanised
- GG - Galvanised / PANTHER (Black)
- PG - Powdercoat / Galvanised
- PP - Powdercoat / PANTHER (Black)
- GPG - Galvanised Powdercoat / Galvanised
- GPP - Galvanised Powdercoat / PANTHER (Black)

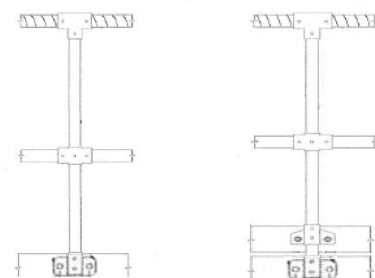
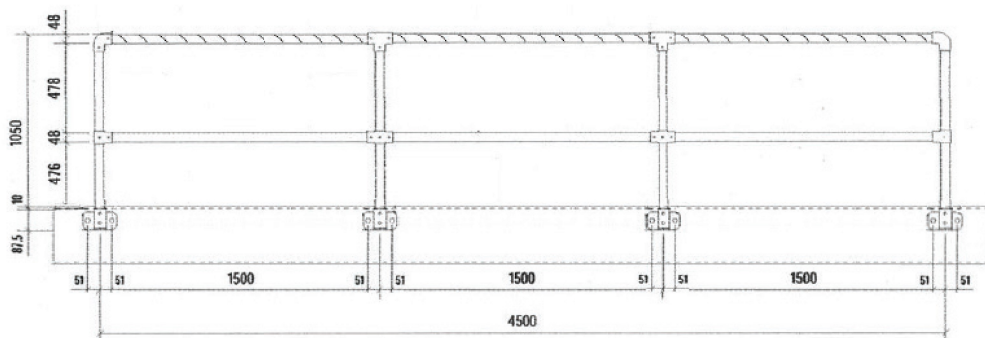

(T)



CODE	NB.	Wall	Material Combinations	Linear M	Toe-plate (T)
C1SM40GG	40	3.2mm	GG	1.5m	
C1SM40GGT	40	3.2mm	GG	1.5m	T
C1SM40GP	40	3.2mm	GP	1.5m	
C1SM40GPT	40	3.2mm	GP	1.5m	T
C1SM40PG	40	3.2mm	PG	1.5m	
C1SM40PGT	40	3.2mm	PG	1.5m	T
C1SM40PP	40	3.2mm	PP	1.5m	
C1SM40PPT	40	3.2mm	PP	1.5m	T
C1SM40GPG	40	3.2mm	GPG	1.5m	
C1SM40GPGT	40	3.2mm	GPG	1.5m	T
C1SM40GPP	40	3.2mm	GPP	1.5m	
C1SM40GPPT	40	3.2mm	GPP	1.5m	T
C1SM32GG	32	3.2mm	GG	1.5m	
C1SM32GGT	32	3.2mm	GG	1.5m	T
C1SM32GP	32	3.2mm	GP	1.5m	
C1SM32GPT	32	3.2mm	GP	1.5m	T
C1SM32PG	32	3.2mm	PG	1.5m	
C1SM32PGT	32	3.2mm	PG	1.5m	T
C1SM32PP	32	3.2mm	PP	1.5m	
C1SM32PPT	32	3.2mm	PP	1.5m	T
C1SM32GPG	32	3.2mm	GPG	1.5m	
C1SM32GPGT	32	3.2mm	GPG	1.5m	T
C1SM32GPP	32	3.2mm	GPP	1.5m	
C1SM32GPPT	32	3.2mm	GPP	1.5m	T

*Mid rail sizing can vary to suit individual order / project.



Type 2:
Flat top mounted continuous

Material Combinations:

Tube / Clamp

- GG - Galvanised / Galvanised
- GG - Galvanised / PANTHER (Black)
- PG - Powdercoat / Galvanised
- PP - Powdercoat / PANTHER (Black)
- GPG - Galvanised Powdercoat / Galvanised
- GPP - Galvanised Powdercoat / PANTHER (Black)

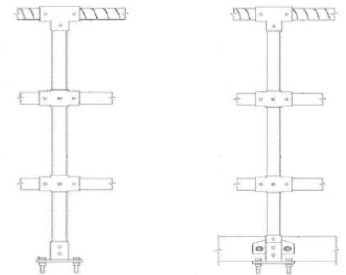
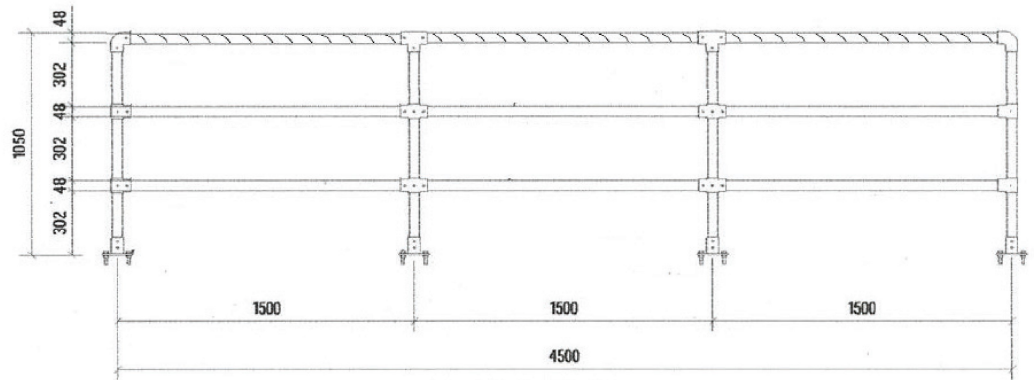

(T)



CODE	NB.	Wall	Material Combinations	Linear M	Toe-plate (T)
C240GG	40	3.2mm	GG	1.5m	
C240GGT	40	3.2mm	GG	1.5m	T
C240GP	40	3.2mm	GP	1.5m	
C240GPT	40	3.2mm	GP	1.5m	T
C240PG	40	3.2mm	PG	1.5m	
C240PGT	40	3.2mm	PG	1.5m	T
C240PP	40	3.2mm	PP	1.5m	
C240PPT	40	3.2mm	PP	1.5m	T
C240GPG	40	3.2mm	GPG	1.5m	
C240GPGT	40	3.2mm	GPG	1.5m	T
C240GPP	40	3.2mm	GPP	1.5m	
C240GPPT	40	3.2mm	GPP	1.5m	T
C232GG	32	3.2mm	GG	1.5m	
C232GGT	32	3.2mm	GG	1.5m	T
C232GP	32	3.2mm	GP	1.5m	
C232GPT	32	3.2mm	GP	1.5m	T
C232PG	32	3.2mm	PG	1.5m	
C232PGT	32	3.2mm	PG	1.5m	T
C232PP	32	3.2mm	PP	1.5m	
C232PPT	32	3.2mm	PP	1.5m	T
C232GPG	32	3.2mm	GPG	1.5m	
C232GPGT	32	3.2mm	GPG	1.5m	T
C232GPP	32	3.2mm	GPP	1.5m	
C232GPPT	32	3.2mm	GPP	1.5m	T





*Mid rail sizing can vary to suit individual order / project.



Type 2 - Side Mount: Flat side mounted continuous

Material Combinations:

Tube / Clamp

-  - GG - Galvanised / Galvanised
-  - GG - Galvanised / PANTHER (Black)
-  - PG - Powdercoat / Galvanised
-  - PP - Powdercoat / PANTHER (Black)
-  - GPG - Galvanised Powdercoat / Galvanised
-  - GPP - Galvanised Powdercoat / PANTHER (Black)

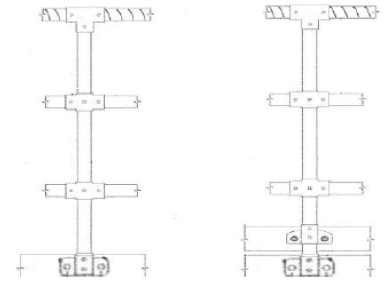
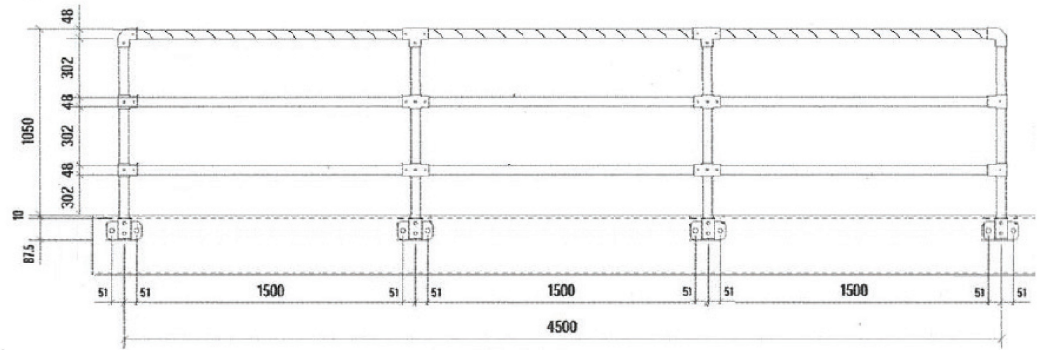

(T)



CODE	NB.	Wall	Material Combinations	Linear M	Toe-plate (T)
C2SM40GG	40	3.2mm	GG	1.5m	
C2SM40GGT	40	3.2mm	GG	1.5m	T
C2SM40GP	40	3.2mm	GP	1.5m	
C2SM40GPT	40	3.2mm	GP	1.5m	T
C2SM40PG	40	3.2mm	PG	1.5m	
C2SM40PGT	40	3.2mm	PG	1.5m	T
C2SM40PP	40	3.2mm	PP	1.5m	
C2SM40PPT	40	3.2mm	PP	1.5m	T
C2SM40GPG	40	3.2mm	GPG	1.5m	
C2SM40GPGT	40	3.2mm	GPG	1.5m	T
C2SM40GPP	40	3.2mm	GPP	1.5m	
C2SM40GPPT	40	3.2mm	GPP	1.5m	T
C2SM32GG	32	3.2mm	GG	1.5m	
C2SM32GGT	32	3.2mm	GG	1.5m	T
C2SM32GP	32	3.2mm	GP	1.5m	
C2SM32GPT	32	3.2mm	GP	1.5m	T
C2SM32PG	32	3.2mm	PG	1.5m	
C2SM32PGT	32	3.2mm	PG	1.5m	T
C2SM32PP	32	3.2mm	PP	1.5m	
C2SM32PPT	32	3.2mm	PP	1.5m	T
C2SM32GPG	32	3.2mm	GPG	1.5m	
C2SM32GPGT	32	3.2mm	GPG	1.5m	T
C2SM32GPP	32	3.2mm	GPP	1.5m	
C2SM32GPPT	32	3.2mm	GPP	1.5m	T







*Mid rail sizing can vary to suit individual order / project.



Type 3:
Stair top mounted Continuous

Material Combinations:

Tube / Clamp

-  - GG - Galvanised / Galvanised
-  - GG - Galvanised / PANTHER (Black)
-  - PG - Powdercoat / Galvanised
-  - PP - Powdercoat / PANTHER (Black)
-  - GPG - Galvanised Powdercoat / Galvanised
-  - GPP - Galvanised Powdercoat / PANTHER (Black)

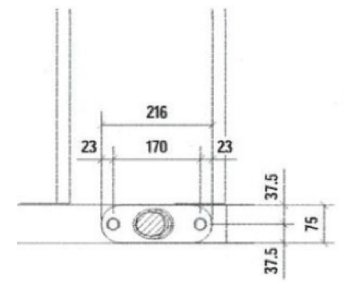
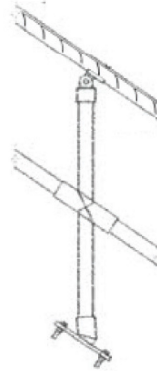
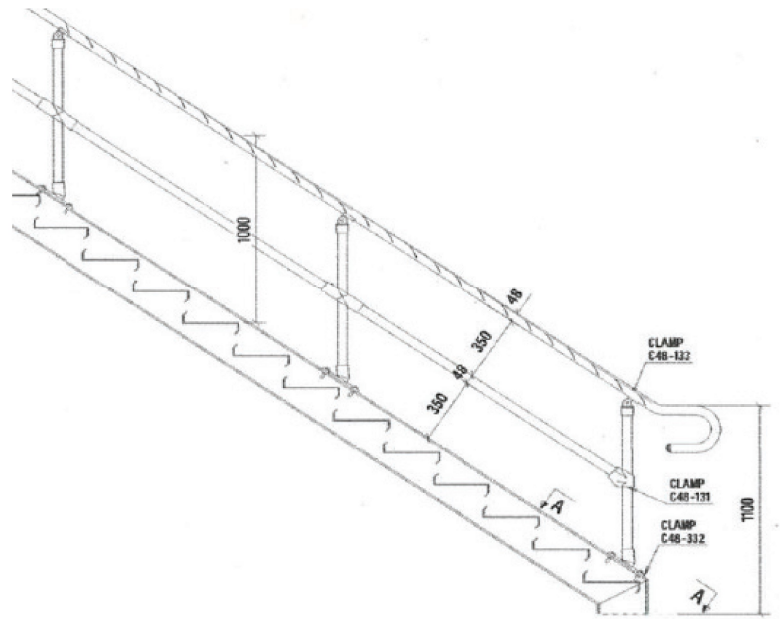

A - A



CODE	NB.	Wall	Material Combinations	Linear M
C340GG	40	3.2mm	GG	1.5m
C340GP	40	3.2mm	GP	1.5m
C340PG	40	3.2mm	PG	1.5m
C340PP	40	3.2mm	PP	1.5m
C340GPG	40	3.2mm	GPG	1.5m
C340GPP	40	3.2mm	PP	1.5m
C332GG	32	3.2mm	GG	1.5m
C332GP	32	3.2mm	GP	1.5m
C332PG	32	3.2mm	PG	1.5m
C332PP	32	3.2mm	PP	1.5m
C332GPG	32	3.2mm	GPG	1.5m
C332GPP	32	3.2mm	GPP	1.5m







*Mid rail sizing can vary to suit individual order / project.



Type 3 - Side Mount:
Stair side mounted continuous

Material Combinations:

Tube / Clamp

-  - **GG** - Galvanised / Galvanised
-  - **GG** - Galvanised / PANTHER (Black)
-  - **PG** - Powdercoat / Galvanised
-  - **PP** - Powdercoat / PANTHER (Black)
-  - **GPG** - Galvanised Powdercoat / Galvanised
-  - **GPP** - Galvanised Powdercoat / PANTHER (Black)

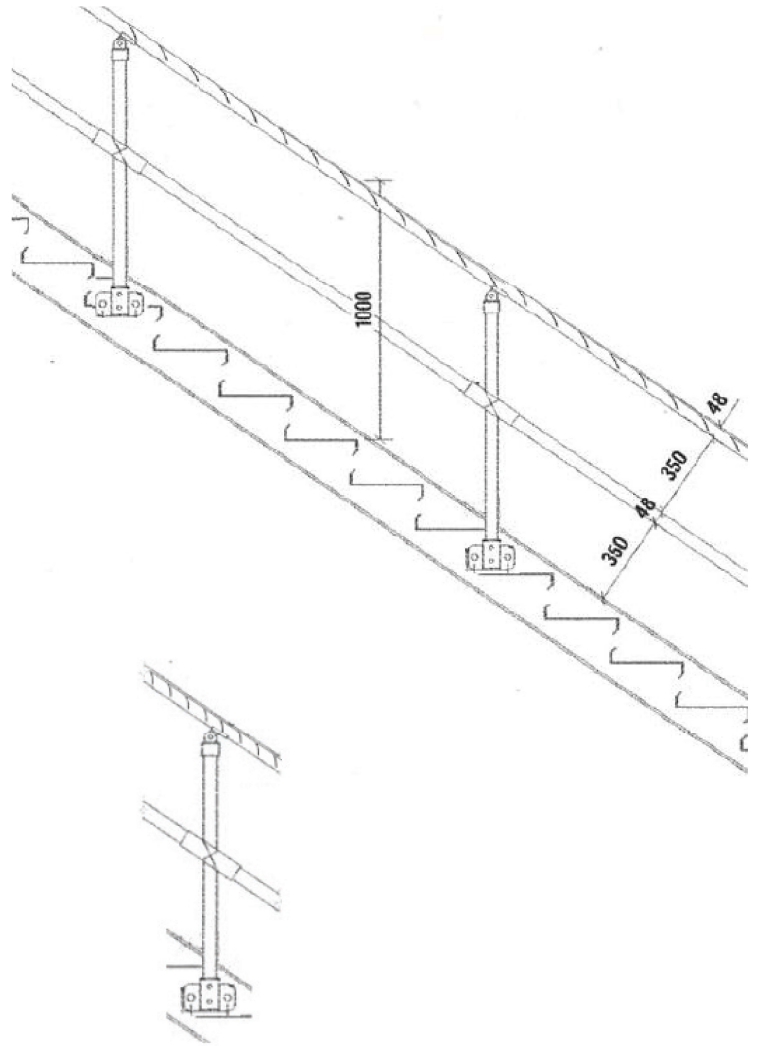

CODE	NB.	Wall	Material Combinations	Linear M
C3SM40GG	40	3.2mm	GG	1.5m
C3SM40GP	40	3.2mm	GP	1.5m
C3SM40PG	40	3.2mm	PG	1.5m
C3SM40PP	40	3.2mm	PP	1.5m
C3SM40GPG	40	3.2mm	GPG	1.5m
C3SM40GPP	40	3.2mm	PP	1.5m
C3SM32GG	32	3.2mm	GG	1.5m
C3SM32GP	32	3.2mm	GP	1.5m
C3SM32PG	32	3.2mm	PG	1.5m
C3SM32PP	32	3.2mm	PP	1.5m
C3SM32GPG	32	3.2mm	GPG	1.5m
C3SM32GPP	32	3.2mm	GPP	1.5m

*Mid rail sizing can vary to suit individual order / project.



Type 4:
Stair top mounted Continuous

Material Combinations:

Tube / Clamp

- GG - Galvanised / Galvanised
- GG - Galvanised / PANTHER (Black)
- PG - Powdercoat / Galvanised
- PP - Powdercoat / PANTHER (Black)
- GPG - Galvanised Powdercoat / Galvanised
- GPP - Galvanised Powdercoat / PANTHER (Black)

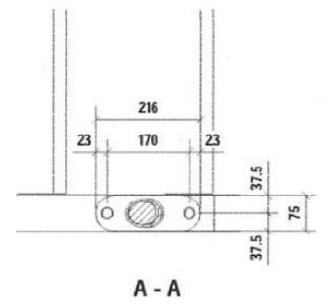
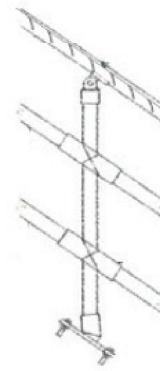
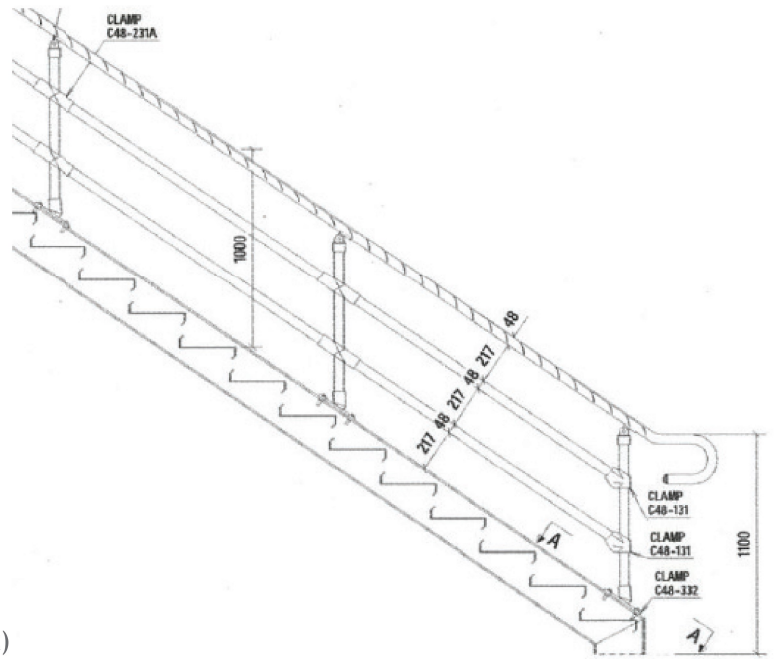

CODE	NB.	Wall	Material Combinations	Linear M
C440GG	40	3.2mm	GG	1.5m
C440GP	40	3.2mm	GP	1.5m
C440PG	40	3.2mm	PG	1.5m
C440PP	40	3.2mm	PP	1.5m
C440GPG	40	3.2mm	GPG	1.5m
C440GPP	40	3.2mm	PP	1.5m
C432GG	32	3.2mm	GG	1.5m
C432GP	32	3.2mm	GP	1.5m
C432PG	32	3.2mm	PG	1.5m
C432PP	32	3.2mm	PP	1.5m
C432GPG	32	3.2mm	GPG	1.5m
C432GPP	32	3.2mm	GPP	1.5m







*Mid rail sizing can vary to suit individual order / project.



Type 4 - Side Mount:
Stair side mounted continuous

Material Combinations:

Tube / Clamp

-  - GG - Galvanised / Galvanised
-  - GG - Galvanised / PANTHER (Black)
-  - PG - Powdercoat / Galvanised
-  - PP - Powdercoat / PANTHER (Black)
-  - GPG - Galvanised Powdercoat / Galvanised
-  - GPP - Galvanised Powdercoat / PANTHER (Black)

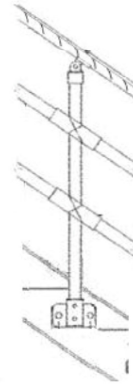
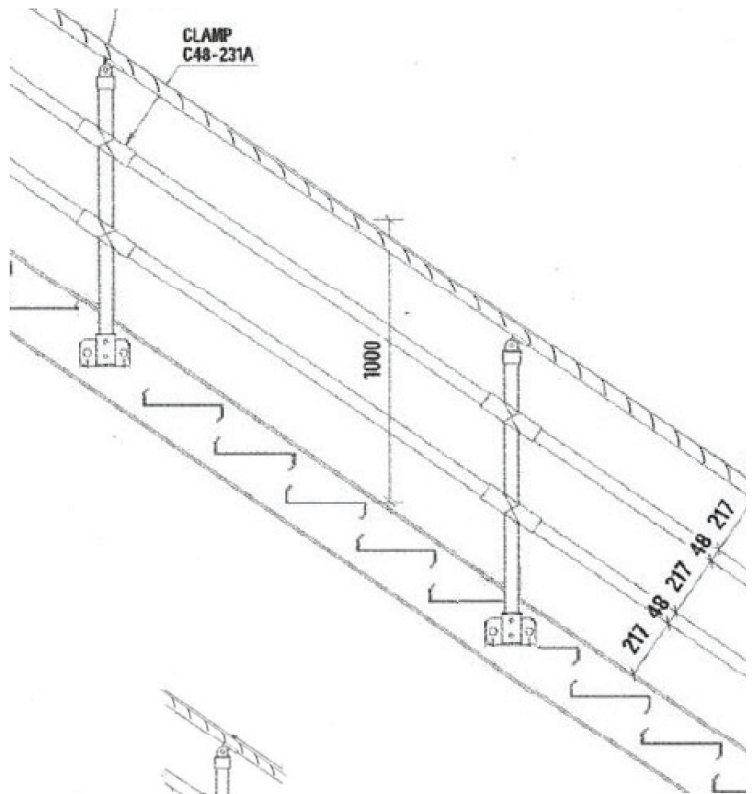

CODE	NB.	Wall	Material Combinations	Linear M
C4SM40GG	40	3.2mm	GG	1.5m
C4SM40GP	40	3.2mm	GP	1.5m
C4SM40PG	40	3.2mm	PG	1.5m
C4SM40PP	40	3.2mm	PP	1.5m
C4SM40GPG	40	3.2mm	GPG	1.5m
C4SM40GPP	40	3.2mm	PP	1.5m
C4SM32GG	32	3.2mm	GG	1.5m
C4SM32GP	32	3.2mm	GP	1.5m
C4SM32PG	32	3.2mm	PG	1.5m
C4SM32PP	32	3.2mm	PP	1.5m
C4SM32GPG	32	3.2mm	GPG	1.5m
C4SM32GPP	32	3.2mm	GPP	1.5m



*Mid rail sizing can vary to suit individual order / project.



Type 5:
Ramp top mounted Continuous

Material Combinations:

Tube / Clamp

-  - GG - Galvanised / Galvanised
-  - GG - Galvanised / PANTHER (Black)
-  - PG - Powdercoat / Galvanised
-  - PP - Powdercoat / PANTHER (Black)
-  - GPG - Galvanised Powdercoat / Galvanised
-  - GPP - Galvanised Powdercoat / PANTHER (Black)

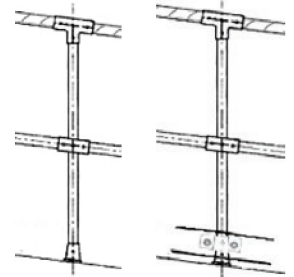
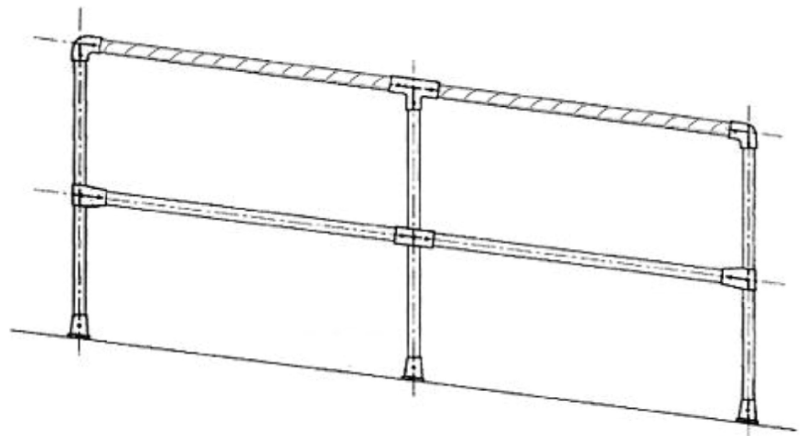

(T)



CODE	NB.	Wall	Material Combinations	Linear M	Toe-plate (T)
C540GG	40	3.2mm	GG	1.5m	
C540GGT	40	3.2mm	GG	1.5m	T
C540GP	40	3.2mm	GP	1.5m	
C540GPT	40	3.2mm	GP	1.5m	T
C540PG	40	3.2mm	PG	1.5m	
C540PGT	40	3.2mm	PG	1.5m	T
C540PP	40	3.2mm	PP	1.5m	
C540PPT	40	3.2mm	PP	1.5m	T
C540GPG	40	3.2mm	GPG	1.5m	
C540GPGT	40	3.2mm	GPG	1.5m	T
C540GPP	40	3.2mm	GPP	1.5m	
C540GPPT	40	3.2mm	GPP	1.5m	T
C532GG	32	3.2mm	GG	1.5m	
C532GGT	32	3.2mm	GG	1.5m	T
C532GP	32	3.2mm	GP	1.5m	
C532GPT	32	3.2mm	GP	1.5m	T
C532PG	32	3.2mm	PG	1.5m	
C532PGT	32	3.2mm	PG	1.5m	T
C532PP	32	3.2mm	PP	1.5m	
C532PPT	32	3.2mm	PP	1.5m	T
C532GPG	32	3.2mm	GPG	1.5m	
C532GPGT	32	3.2mm	GPG	1.5m	T
C532GPP	32	3.2mm	GPP	1.5m	
C532GPPT	32	3.2mm	GPP	1.5m	T







*Mid rail sizing can vary to suit individual order / project.



Type 5 - Side Mount:
Ramp side mounted continuous

Material Combinations:

Tube / Clamp

-  - GG - Galvanised / Galvanised
-  - GG - Galvanised / PANTHER (Black)
-  - PG - Powdercoat / Galvanised
-  - PP - Powdercoat / PANTHER (Black)
-  - GPG - Galvanised Powdercoat / Galvanised
-  - GPP - Galvanised Powdercoat / PANTHER (Black)

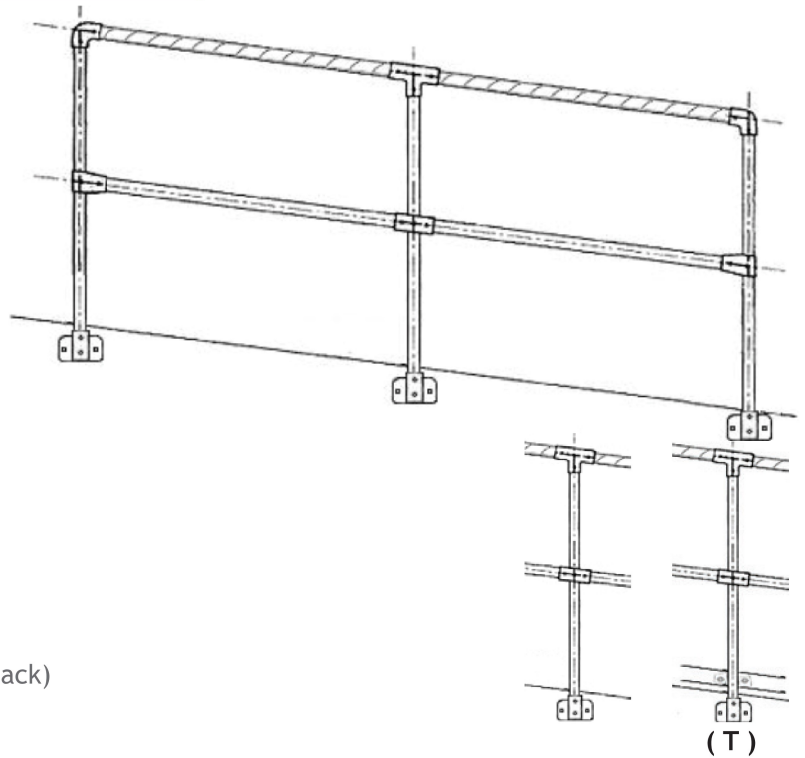

CODE	NB.	Wall	Material Combinations	Linear M	Toe-plate (T)
C5SM40GG	40	3.2mm	GG	1.5m	
C5SM40GGT	40	3.2mm	GG	1.5m	T
C5SM40GP	40	3.2mm	GP	1.5m	
C5SM40GPT	40	3.2mm	GP	1.5m	T
C5SM40PG	40	3.2mm	PG	1.5m	
C5SM40PGT	40	3.2mm	PG	1.5m	T
C5SM40PP	40	3.2mm	PP	1.5m	
C5SM40PPT	40	3.2mm	PP	1.5m	T
C5SM40GPG	40	3.2mm	GPG	1.5m	
C5SM40GPGT	40	3.2mm	GPG	1.5m	T
C5SM40GPP	40	3.2mm	GPP	1.5m	
C5SM40GPPT	40	3.2mm	GPP	1.5m	T
C5SM32GG	32	3.2mm	GG	1.5m	
C5SM32GGT	32	3.2mm	GG	1.5m	T
C5SM32GP	32	3.2mm	GP	1.5m	
C5SM32GPT	32	3.2mm	GP	1.5m	T
C5SM32PG	32	3.2mm	PG	1.5m	
C5SM32PGT	32	3.2mm	PG	1.5m	T
C5SM32PP	32	3.2mm	PP	1.5m	
C5SM32PPT	32	3.2mm	PP	1.5m	T
C5SM32GPG	32	3.2mm	GPG	1.5m	
C5SM32GPGT	32	3.2mm	GPG	1.5m	T
C5SM32GPP	32	3.2mm	GPP	1.5m	
C5SM32GPPT	32	3.2mm	GPP	1.5m	T

*Mid rail sizing can vary to suit individual order / project.



Type 5:
Top mounted Continuous Balustrading

Material Combinations:

Tube / Clamp

- GG - Galvanised / Galvanised
- GG - Galvanised / PANTHER (Black)
- PG - Powdercoat / Galvanised
- PP - Powdercoat / PANTHER (Black)
- GPG - Galvanised Powdercoat / Galvanised
- GPP - Galvanised Powdercoat / PANTHER (Black)

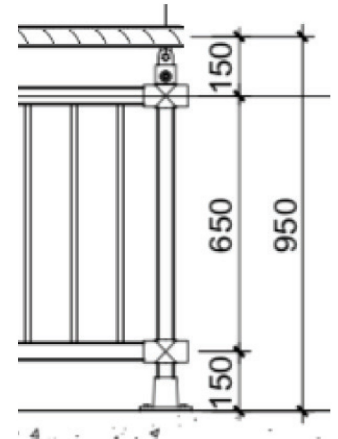
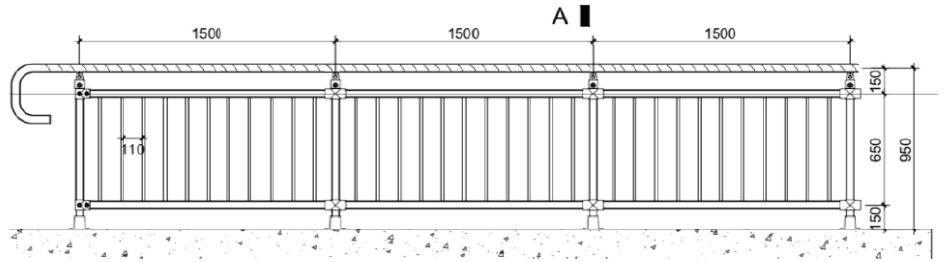

CODE	NB.	Wall	Material Combinations	Linear M
BAL40GG	40	3.2mm	GG	1.5m
BAL40GP	40	3.2mm	GP	1.5m
BAL40PG	40	3.2mm	PG	1.5m
BAL40PP	40	3.2mm	PP	1.5m
BAL40GPG	40	3.2mm	GPG	1.5m
BAL40GPP	40	3.2mm	PP	1.5m
BAL32GG	32	3.2mm	GG	1.5m
BAL32GP	32	3.2mm	GP	1.5m
BAL32PG	32	3.2mm	PG	1.5m
BAL32PP	32	3.2mm	PP	1.5m
BAL32GPG	32	3.2mm	GPG	1.5m
BAL32GPP	32	3.2mm	GPP	1.5m

*Mid rail sizing can vary to suit individual order / project.



T2 - TOP MOUNT (2 FIXINGS)

Concrete - using M12 x 100mm Galvanised screwbolts.

Steel - using M16 hi-tensile galvanised bolts.

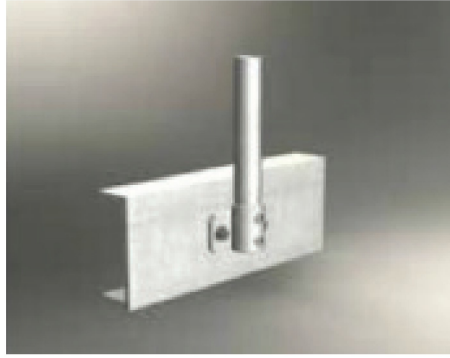

F2 - FAC MOUNT (2 FIXINGS)

Concrete - using M12 x 100mm Galvanised screwbolts.

Steel - using M16 hi-tensile galvanised bolts.



C11 - CHANNEL MOUNT (2 FIXINGS)

110mm Offset

Steel - using M16 hi-tensile galvanised bolts.

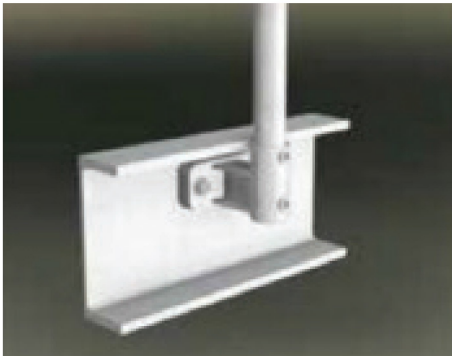

C13 - CHANNEL MOUNT (2 FIXINGS)

130mm Offset

Steel - using M16 hi-tensile galvanised bolts.

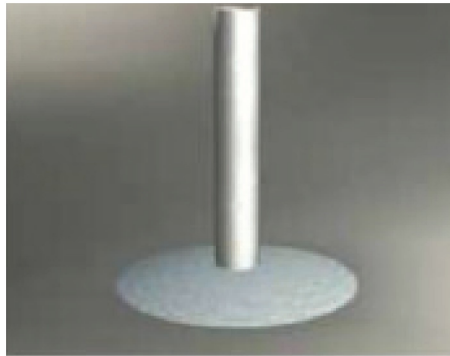

GD - INGROUND MOUNT

As per engineers specifications



CD - CORED MOUNT

As per engineers specifications

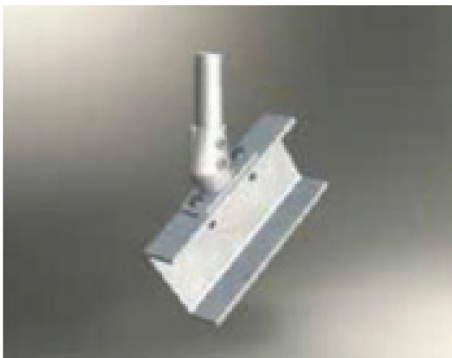

AM - ANGLE MOUNT (2 FIXINGS)

Concrete - using M12 x 100mm galvanised screwbolts.

Steel - using M16 hi-tensile galvanised bolts.



- 3M reflective line
- Hot dip galvanising + Polyester Powder coating paint
- 4.78mm Wall thickness
- Fixed & Core filled / embedment type

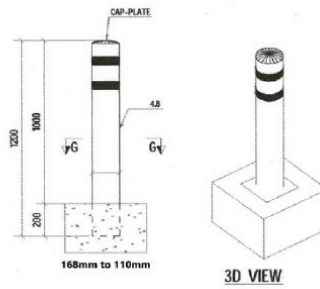

Blanc 9010 ○

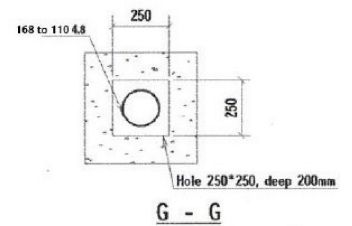

CODE	Size	Fixing	Finish
AB3.1	1200x168x4.8	embedment	Galvanised + Powdercoat
AB3.2	1200x140x4.8	embedment	Galvanised + Powdercoat
AB3.2	1200x110x4.8	embedment	Galvanised + Powdercoat

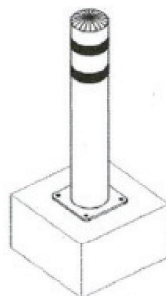
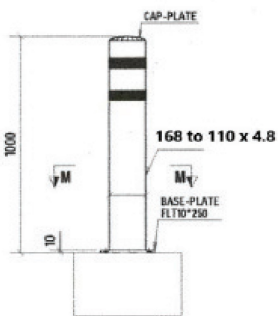

3D VIEW-T5.1



Gris 7035 ●



Jaune signalisation 1023 ●

CODE	Size	Fixing	Finish
AB5.1	1000x168x4.8	Base plate	Powdercoat
AB5.2	1000x140x4.8	Base plate	Powdercoat
AB5.2	1000x110x4.8	Base plate	Powdercoat

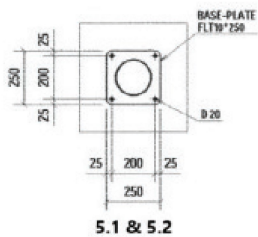

5.1 & 5.2

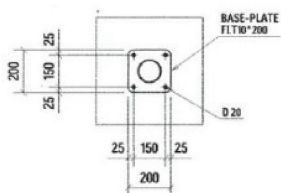





5.3



Galvanisé ●

COMBINATIONS

KAG can:

-  Supply quotations in Modular handrail
-  Supply quotations in Fully Welded sections
-  Supply posts pre-fitted with clamps
-  KAG top rail powder coated

Material	Item/No.	Size	To suit pipe O.Dmm	Length
----------	----------	------	--------------------	--------

KAG-TRG-01 Top Rail Mild Steel Galvanised Powdercoat		D	48.3	6.0m
---	--	---	------	------

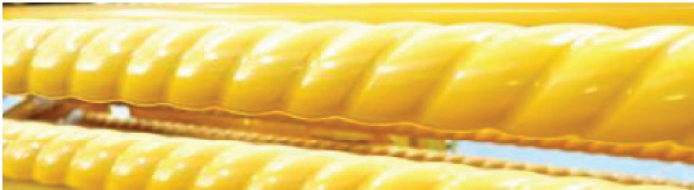

KAG-TRG-02 Top Rail KAG Mild Steel Galvanised		D	48.3	6.0m
---	--	---	------	------

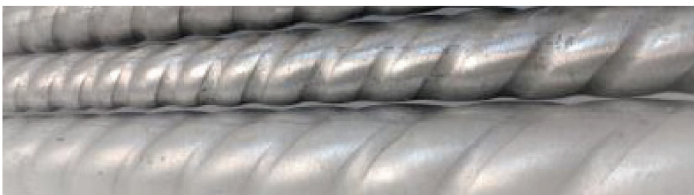

KAG

Safety Rail

Pre-Fab Post Powder Coated in safety Yellow	Size
--	------

(0 deg to 11 deg) Pre-Fab Ramp End Post Powder Coated in Safety Yellow		C42	D48
---	---	-----	-----

(0 deg to 11 deg) Pre-Fab Ramp Mid Post Powder Coated in Safety Yellow		C42	D48
---	---	-----	-----

Pre-Fab Post Powder Coated in safety Yellow	Size
--	------

Pre-Fab End Post Powder Coated in Safety Yellow		C42	D48
---	---	-----	-----

Pre-Fab Mid Post Powder Coated in Safety Yellow		C42	D48
---	---	-----	-----

Pre-Fab Corner Post Powder Coated in Safety Yellow		C42	D48
--	---	-----	-----



KAG

Safety Rail

SIMPLE STEPS TO ORDER:

STEP 1 - SELECT (Configurations)

KAG has done the hard work for you, with “ready to assemble” components into an easily connected modular handrail system.

The LION range lets you be the king of the handrail jungle, simply pick your configuration type:

- 🛒 Configuration type 1
- 🛒 Configuration type 1 - Side Mount
- 🛒 Configuration type 2
- 🛒 Configuration type 2 - Side Mount
- 🛒 Configuration type 3
- 🛒 Configuration type 3 - Side Mount
- 🛒 Configuration type 4
- 🛒 Configuration type 4 - Side Mount
- 🛒 Configuration type 5
- 🛒 Configuration type 5 - Side Mount
- 🛒 KAG Modular Balustrading

All configurations come with necessary cornering and ends.

STEP 2 - SELECT (material combinations)

The LION range is available in many top quality and high performance materials and finishes. With a new PANTHER (black) range on the market - for a clean and modern aesthetic look.

Simply mix and match any combination to suit your needs.

STEP 3 - SELECT (custom options)

If you can't find the configurations you require, please send us drawings of your project and our team here at KAG will take the hard work out of it and put together a configuration for you.

STEP 4 - SELECT (Accessories)

KAG have a range of safety Bollard systems - to suit any access situation requiring protection.

Custom colours to suit your company or need are also available.



STEP 5 - ORDER

Please refer to KAG order form 121.



Maximising grip & safety

Maximising your grip on ladders, work platforms, stairs, grab rails, balustrading and walkways in ALL conditions.

-  **Easy to install**
-  **Custom fabrication available**
-  **Sizing from 19mm up to 50mm diameter tube.**

Swage pattern can start and stop at any point along the grab rail - allowing for standard fittings, tees, elbows, end caps and bends.

Our innovative fixtures and fitting are designed to outperform 'standard' products through inspired design backed by outstanding quality and versatility.

Quality you can trust

- 🛡️ *Minimises slips, accidents, injuries and strains.*
- 🛡️ *All products are independently tested for quality and effectiveness.*
- 🛡️ *Meet or exceed Australian regulations and standards.*
- 🛡️ *Australian designed, made and owned.*
- 🛡️ *Available in a wide range of materials, sizes and wall thicknesses - stainless steel, aluminium and galvanised.*
- 🛡️ *Compliance standards: AS1428.1-2009*

STAINLESS STEEL	304, 316, 409 in standard #320 or #600 mirror finishes - can be produced up to 4mm thick.
ALUMINIUM	All grades - some grades can be anodised (clear or coloured)
STEEL	Mild; zinc plated; galvanised (can be powder coated)
GALVANISED	Tube/Pipe

Acusafe Australia Head Quarters

ACUSAFE
Enhancing Safety

www.kagrail.com



KAG
Safety Rail

